

Washing machine

en Operating and installation instructions



BOSCH

Index

	p.		p.
General safety guidelines and warnings	4	Child safety device – depending on the model	12
Removal and disposal of packaging	4	Detergents and additives	12
Environmental protection / Saving energy	5	First washing cycle	13
Installing the appliance	5	Preparing the laundry for washing	13
Removing the transport security devices	5	Loading the laundry	14
Fixing the appliance	6	Washing laundry	14
Connecting to the water supply	6	End of wash programme/Removing the laundry	15
Water drainage	7	Cleaning / Maintenance / Frost protection	16
Connecting to the electricity supply	7	Technical data	17
Getting to know your new appliance	8	Minor faults with simple solutions	18
Programme selector	9	After Sales Service	19
Extra function and start buttons	10	Consumption figures	19
Screen	10		

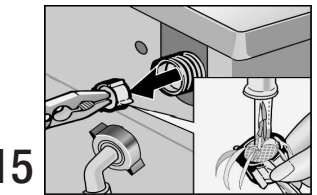
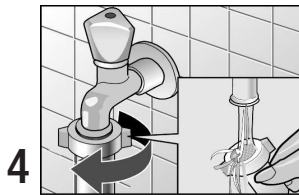
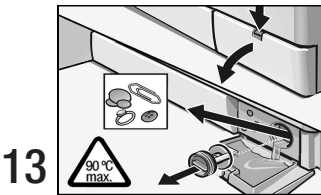
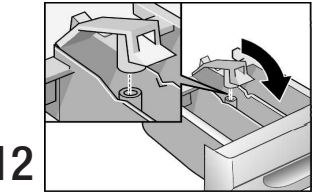
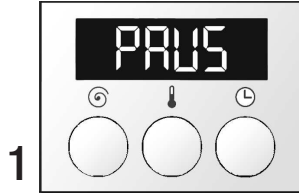
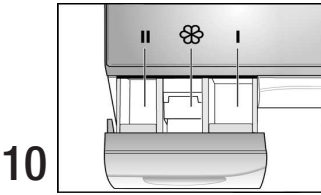
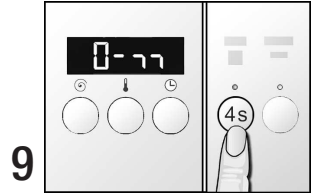
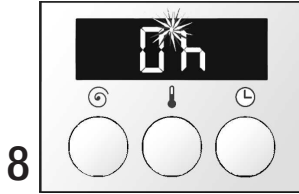
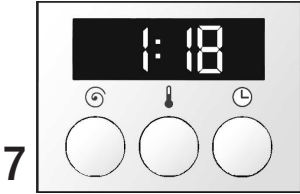
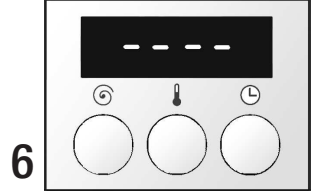
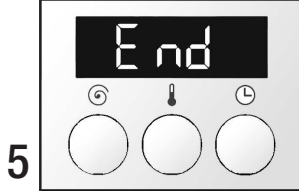
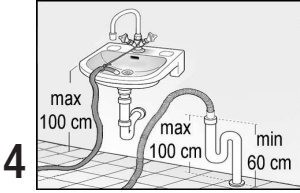
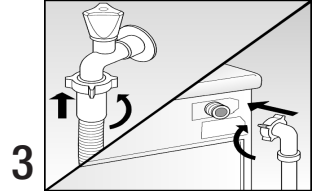
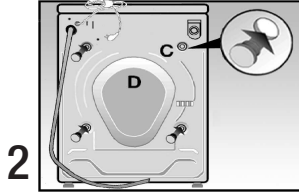
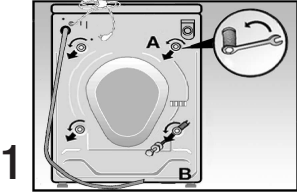

General safety guidelines and warnings

This appliance complies with current safety standards in the sector.

Points to bear in mind before operating the appliance:

- ! Read these instructions carefully before operating the appliance. They contain important information and advice relating to the installation, use and safety of the appliance.
- ! Keep the instructions for using the appliance for future reference and/or any possible future owner.
- ! Set up the appliance according to the assembly instructions. Remove the transport securing devices and keep them.
- ! Do not connect any appliance with visible signs of damage or flaws to the mains. If in doubt, you should contact the After Sales Service or the distributor where the appliance was acquired.
- ! If the power cable is damaged, it should be replaced with a special one supplied by the Manufacturer's Official Service.

Points to bear in mind when washing clothes:

- ! The appliance should only be used with cold water from the public water supply.
- ! The appliance should only be used for washing clothes suited to household washing machines.
- ! Do not leave the machine unguarded if children are present.
- ! Keep pets away from the machine.
- ! Take care when the hot water is being emptied.

Points to note for the protection of the appliance:

- ! Do not get on top of the appliance.
- ! Do not use the door as a support or stand on it either.

Points to note when transporting the machine:

- ! Fix the transport securing devices in their positions.
- ! Empty any water remaining inside the appliance.
- ! Pay careful attention during transportation of the appliance! Do not use the parts or controls on the front to hold or lift the appliance!

Removal and disposal of packaging

Removal and disposal of your new appliance's packaging material

All the materials used are environmentally friendly and can be recycled or reused.

Disposal of an old appliance

Worn-out appliances contain valuable materials that can be recovered, if the appliance is taken to an official recyclable waste recovery centre. Actively contribute to the protection of the environment by ensuring that your old appliance is disposed of in a way that respects the environment.



This appliance is labelled in accordance with European Directive 2002/96/EC concerning used electrical and electronic appliances (waste electrical and electronic equipment - WEEE). The guideline determines the framework for the return and recycling of used appliances as applicable throughout the EU.

Environmental protection / Saving energy

- The most economic and least aggressive use from an environmental point of view is always to load the maximum amount of laundry pos-

sible into the machine according to the selected programme.

Installing the appliance

- ! When installing the appliance and connecting it to the water supply and mains, the guidelines and warnings indicated as well as the general observations, regulations and stipulations of the local water and electricity supply companies should be closely observed.
- ! Be careful when lifting the appliance! **Danger of injury!**
- ! Do not lift the appliance by its protruding parts or controls!
- ! If in doubt, you should ask a specialist technician to connect the appliance to the water supply and electric mains.

Positioning

In order to guarantee the safe and secure positioning of the appliance during the spin, the surface or location where the appliance is to be installed should be flat and firm. Soft floor linings, such as fitted carpets or other materials with a foam rubber face, are not suitable locations for the machine.

- ! If necessary, fix the appliance to the floor using attachment lugs (obtained from the After Sales Service) secured to the feet of the machine (particularly when setting up a combined column of washing and drying).
- ! In the event of setting up the appliance on a stand or raised base, it will be necessary to secure the feet of the appliance with the lugs in order to avoid the uncontrolled movement of the machine during the spin cycle.

The attachment lugs can be acquired as well as a spare set from the distributor.

Protective cover

If it is necessary to remove the protective cover in order to install the appliance under the work surface, a technician should put in a cover plate to avoid dirt, water, etc. from entering the appliance and therefore extend its working life. This piece may be obtained from After Sales Service.

Removing the transport security devices (pic. 1, 2)

- ! Before initial use of the machine, it is essential to remove the transport securing devices, which are in the rear part of the machine, with a suitable spanner.
- ! **Warning!** Danger of injury if spanner slips!
- Loosen and remove the 4 attachment screws «**A**».
- Remove the four spacers «**B**» which have fallen on the floor. Gently tilt the appliance forward.

- Assemble the protective covers «**C**» which are inside the bag with the documentation.
- ! Keep the transport securing devices in case you need to move the appliance in future.

The appliance should only be moved with the transport securing devices in place. To fit them, remove the back panel «**D**» from the machine and carry out the operations given above in reverse order.

Fixing the appliance

! The appliance must be firmly fixed and settled on its four feet, not rocking.

If necessary, level and stabilise the appliance using the adjustable feet.

○ Loosen the locknuts of the feet.

○ Correct the height of the feet.

○ Securely tighten the locknuts so that the adjustments made to the feet cannot be altered accidentally.

Connecting to the water supply (pic. 3)

The water inlet requires a cold water inlet pipe of the type commonly used in homes (included; two pipes in case of models featured for hot water), with a minimum pressure of 1 bar.

If pressure is higher than 10 bar, a pressure-reducing valve must be inserted between the appliance and the water supply.

! The appliance should be connected to the water supply using new feed pipes. The old feed pipes should not be reused.

! Do not connect the appliance to a mixer tap without the pressure of a boiler! If in doubt, you should get a specialist technician to assemble and connect the appliance to the water inlet and outlet supplies.

! **Warning!** The connections or couplings between the appliance and the water supply withstand the maximum pressure. Check that the circuit is watertight by turning the tap on fully!

! Remove the filter at the end of the solenoid valve in order to clean it (see «Cleaning / Maintenance / Frost protection»). The other filter, attached to the tap, should be cleaned in the pipe itself (it is not detachable).

! In order to prevent damage caused by water leaks or flooding, the tap should always be turned off after the appliance has completed its work cycles and during lengthy periods of inactivity.

! Only tighten the plastic locknuts of the pipe's connections by hand.

Water drainage (pic. 4)

- ! When setting up and connecting the appliance to the water outlet supply, make sure the pipe is not bent or twisted. Do not pull the pipe!
- ! If draining through a sink, make sure the discharge pipe cannot be moved from its location. Also check the rapid discharge of water through the draining of the sink. Make sure the plug is not blocking the sink. **Danger of flooding!**

Connecting to the electricity supply

- ! The appliance must only be connected to an alternating current power supply via a socket that has been properly installed and earthed.
- ! The voltage which is given on the specifications plate must coincide with the mains voltage where the appliance is connected.
- ! The connection values and the fuses or trip switch that is required are given on the specifications plate.
- ! Make sure that the socket and the plug connected to the appliance are compatible and that the plug is properly earthed.
- ! Do not use multiple plugs, cables or connections or extension cables.
- ! In the event of using a current-operated circuit breaker, only one with the symbol  can be used. Only this type of protection switch will assure the observance of current regulations on the matter.
- ! Only remove the power plug from the mains by holding the plug itself.
- ! Do not insert or remove the power plug with wet hands.

Getting to know your new appliance

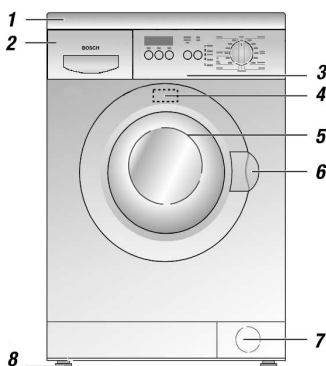

1. Protective plate (Cover).
2. Detergent and additive drawer
3. Control panel
4. Rating plate
5. Door
6. Lever for opening the door
7. Water outlet pump
8. Adjustable supports for levelling the machine

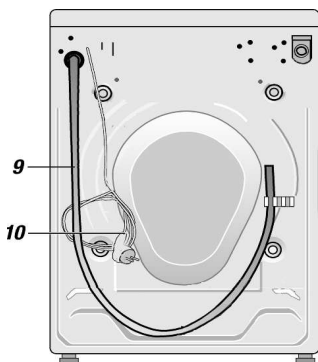

9. Water outlet pipe.
10. Pin (power plug)
11. Screen and screen buttons:
 - «⊙»: spin
 - «↓»: temperature
 - «⊙»: time
12. Button **Start/Pause** «Inicio ◊»
13. Button **Rinse plus** «↶»
14. Washing machine status indicator lights
15. Programme selector

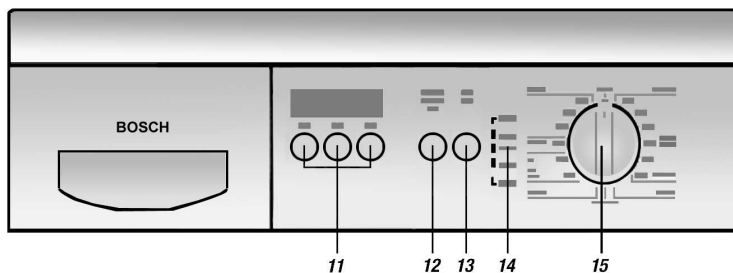

Programme selector

Selecting and adjusting programmes using the **programme selector control**. Turn the control and set the mark to the required programme. The control does not turn as the programme continues.

Washing programmes (depending on model):

«Resistentes/Algod. (Cottons)»

normal: Colour fast cottons or linen.

intensivo (Stains): Colour fast cottons or linen (intensive wash).

Eco: Energy saving programme. A longer wash cycle reduces energy consumption.

+Prelava. (Prewash): Very dirty fast solid colours.

 **Fácil (Easy Iron):** After the spin, the laundry is fluffier in the drum to avoid creases.

«Sintéticos (Easy-Care)»

normal: Cotton, synthetic or mixed materials, delicate fabrics.

intensivo (Stains): cotton, synthetic or mixed delicate fabrics (intensive wash).

+Prelava. (Prewash): very dirty synthetic delicate laundry.

«Mix»

Cotton and delicate laundry; different types of laundry can be washed together.

«Delicado (Delicate/Silk)»

Cotton, synthetic or mixed materials, curtains. Does not spin between the rinse cycles.

«Lana/lã (Wool)»

Wool or wool mix machine washable laundry.

Additional programmes



Rápido (Quick): fast programme for slightly dirty laundry.

Rinse : rinse cycle with low-energy spin. Can also be used for delicate laundry.

Centrif. adicional  (Spin): extra spin cycle; the wash or rinse water is drained before the laundry is spun.

Empty : rinsing water emptying after selecting a wash programme with the option **without final spin** "----".

! Both the maximum speed of the spin and the maximum temperature are electronically limited in all programmes except for «Resistentes/Algod.».

(Follow the instructions on the labels)	Programme	Default temperature (°C)	Selectable temperature (°C)	Approx. duration (min)*
Resistentes/Algod.	normal	60	Cold – 60	67
	intensivo 	60	Cold – 90	115
	Eco	60	Cold – 60	140
	+Prelava.	60	Cold – 90	141
Sintéticos	 Fácil	60	Cold – 60	79
	normal	40	Cold – 60	58
	Intensivo	40	Cold – 60	75
	+Prelava.	40	Cold – 60	101
Mix		40	Cold – 40	55
Delicado		30	Cold – 40	44
Lana/lã 		30	Cold – 40	61
Rápido		30	Cold – 40	15

*With default temperature

Extra function and start buttons

: an extra rinse cycle is performed.

Inicio : To start the wash cycle. A programme must previously have been selected.



Screen (pic. 5 – 8)

The screen shows the information that has to be indicated in some cases before the programme is started, such as the time remaining, the wash temperature or the spin speed, etc. Once the programme has started, the time remaining is shown; “Εηδ” will be shown when the programme has finished; is “----” (**without final spin**) is selected, “---” will appear to remind us that there is still water in the washing machine.

“Spin ”: Press this button to select the required spin speed. With the extra function **without final spin** “---”.

Spin speed

Rpm

(depending on model)	Programme
1200 / 1000	Resistentes/Algod.
800 / 800	Sintéticos
800 / 800	Mix
600 / 600	Delicado
800 / 800	Lana/lã 
800 / 800	Rápido
800 / 800	
800 / 800	 Centrif. adicional

! If during the wash, the “” button is pressed once briefly, the selected speed is shown; if it is pressed repeatedly, the selection is modified (bear in mind that following the final spin the new value will have no effect).

“Temperature ”: Press this button to select the wash temperature required for the selected programme (see “Programme selector” table).

! If during the wash, the “” button is pressed once briefly, the selected temperature is shown; if it is pressed repeatedly, the selection is modified (bear in mind that when the temperature has reached the required level, the new value will have no effect).

! For safety reasons, the machine does not start until the door is properly closed.

“Time ”: The start time may be adjusted between 0 and 24 hours. The time will be cancelled when the button is pressed once more. The programme will begin automatically at the time programmed.

Time remaining

When the programme is selected, its approximate duration will be shown.

 Set the programme selector control to the desired programme. The warning light «**pre-parado–lavar**» flashes. The screen shows the time remaining (programme duration), for instance 1:18 = 1 hour and 18 minutes..

At the end of the programme “Εηδ” appears on the screen. If “----” (**without final spin**) has been selected, “---” appears when the programme is finished.

! While the programme is running, its duration may increase or decrease due to the following:

Time increase:

- extra rinse cycle if the laundry has too much foam,
- multiple spin if the laundry is not well distributed around the drum,
- increase in heating time if, for instance, the water is too cold,
- excessively low water pressure,
- selection of an extra option,
- highly absorbent laundry.

Time decrease:

- light loads,
- decrease in heating time if, for instance, the temperature of the water is very warm.

Start time

Before a programme begins, the number of hours the programme start must be delayed (start time) may be specified.

- Set the programme selector control to the desired programme. The warning light «**preparado-lavar**» flashes. The screen shows the time remaining.
- Press the "⏸" button. The screen shows "0 h" (=hour).
- Press the "⏸" button once more to select the required start time.
- ! The start time may be programmed in blocks of 1 hour. The start may be delayed up to 24 hours. If a start time has been programmed to 24 hours, it can be returned to "0 h" by pressing the "⏸" button once more.

The start time begins to run after pressing the «**Inicio** ⏪» button. The cursor which is between the number and the "h" and the pilot lights «**Inicio** ⏪» and «**preparado-lavar**» flashes until the start time finishes and the programme begins. These indicators then come on continuously.

- ! The start count down is performed in hours. When the time comes for starting, the programme starts automatically and the time remaining appears.

The start time may be modified at any time before the programme begins.

- Press the "⏸" button until the required time appears. The selected programme will not be modified.
- ! If the programme is modified, the start time will also be annulled. The screen then shows the time remaining. If necessary, restart the start time.



While the start time is activated, it is possible to put laundry in or remove laundry from the washing machine. Close the door immediately after loading or emptying the drum.

Child safety device – depending on the model (pic. 9)

It is possible to avoid certain functions of the washing machine from accidentally being modified.

With the child safety device activated, no modifications can be made to the current wash, and the “**U - r**” appears if someone attempts to modify the selected programme. If the machine is turned off and on again, the running programme will restart where it was interrupted.

Turning on the child safety device

- Set the programme selector control to the desired programme. Make all necessary adjustments.
- Put the laundry in the machine and close the door.
- Press the «**Inicio** » button. The programme starts. Press the «**Inicio** » button and hold it down (approximately 4 seconds) until the “**U - r**” symbol appears, after which “**PAUS**” appears for a few moments (depending on the model).

- Release the «**Inicio** » button. The child safety device is activated and the “**U - r**” symbol appears. The screen shows the time remaining and the “**U - r**” symbol throughout the washing cycle.

If an attempt is made to modify the running programme, the child safety device guarantees that the washing machine continues with the programme you had selected. Then the screen only shows the “**U - r**” symbol.

Turning off the child safety device

To make any alterations to programmes and to end programmes with the “**----**” (**without final spin**) option, the child safety device must first be deactivated.

- Press the «**Inicio** » button and hold it down (approximately 4 seconds) until the “**U - r**” goes out.

Detergents and additives

All standard use detergents for automatic washing machines can be used.

- ! Do not use detergents with solvents in the washing machine! **Danger of explosion!**
- ! Do not use additives, cleaning sprays or stain removers in the vicinity of the appliance, as they may damage it.

! Keep detergents and additives in a safe place, away from children.



Amount of detergent

Only using the correct measure of detergent will guarantee good wash results. Note the manufacturer's recommendations.

First washing cycle

Carry out the first wash without any laundry in the machine to remove residual water left from testing the machine at the factory.

- Pour approximately two litres of water and half a measuring glass of normal detergent into compartment **II** of the detergent drawer.
- Turn the programme selector to «**Resistentes/Algod., +Prelava.**» and the temperature to **90 °C**. The «**preparado-lavar**» indicator flashes.

- Press the «**Inicio** » button. The «**preparado-lavar**» and «**Inicio** » indicators come on permanently.
- The «**centrifugar-terminado**» light flashes when the programme has ended. The «**Inicio** » indicator goes out, and the screen shows “E n d”. Turn the programme selector to «**Stop**».

Preparing the laundry for washing

Sorting the laundry

- Sort the laundry according to the symbols on the labels.
- ! Wool or wool composite knitwear must include the indication «Will not shrink» or «Machine washable».

Items labelled with the following symbol should not be washed in the machine: 

- Sort laundry by colours. Wash whites and colours separately, otherwise white garments may change colour.
- ! New colour garments should be washed separately. **Risk of colour running.**
- Sort the laundry according to the maximum permitted load for the machine. Do not overload the machine, as this greatly reduces its performance and the result of the wash.

Maximum load allowable for washing:

Resistentes/Algod.	6,00 kg
Sintéticos, Mix	3,00 kg
Delicado, Lana/lã  ,	
Rápido	2,00 kg

Practical guidelines

- ! Remove foreign bodies and metal objects (safety pins, clips, ...) from clothing.
- ! Remove bits of sand by brushing clothing.
- ! Do up all zips and buttons of cushion covers.
- Wash very delicate laundry (tights, curtains...) and very small items (socks, handkerchiefs...) in a net or cushion cover.
- Turn trousers and knitwear inside out (shirts, sweatshirts...).
- Make sure that bras with items inserted (hoops, etc.) are suitable for washing in the washing machine.
- ! Put bras with inserted items into a cushion cover, since these items may fall through the drum if they come loose and damage the washing machine.

Removing stains

When stains appear, they should be treated or removed immediately with soap and water. Do not rub vigorously on the clothing. Stains that are very stubborn or dry sometimes only vanish after several washes.

Loading the laundry (pic. 10)

Open the door

- Pull the lever.

Put the laundry in the washing machine

! Garments previously treated with detergents containing solvents, such as stain removers etc., should be dried outside before being washed. **Danger of explosion!**

! Before adding the laundry to the washing machine, make sure there are no foreign bodies or animals enclosed in the drum.

- Add the outspread and unfolded laundry, mixing large and small items.

Close the door

! Make sure there are no items left trapped between the door and the rubber seal.

- Close the door by pressing it against the frame of the appliance, until you can hear the door closing shut.

Pour detergent

- Pour detergent without exceeding the maximum filling level mark.
 - Compartment **I**: Detergent for pre-washing.
 - Compartment **II**: Detergent for main wash, limescale remover, stain removing salt...
 - Compartment : Additives for the last rinse, for example softeners.
- Turn on the tap.

Washing laundry (pic. 11)

Starting a programme

- Set the programme selector control to the desired programme. The «**preparado-lavar**» indicator flashes.
- Press the extra function button (optional). The indicator lights.
- If necessary, select the spin speed or “----” (**without final spin**), the temperature and the start time.
- Press the «**Inicio** » button. The «**preparado-lavar**» indicator comes on. The wash programme starts (if the start time has been selected, it will start automatically at the programmed time).



Modifying a selected programme

! Temporarily deactivate the child safety device, if activated.



- Set the programme selector control to the desired wash programme. The «**preparado-lavar**» indicator flashes.
- Press the «**Inicio** » button. The «**preparado-lavar**» indicator comes on. The selected programme commences.

Cancelling a wash programme



! Temporarily deactivate the child safety device, if activated.

- Turn the programme selector to «» or « **Centrif. adicional**». The «**preparado-lavar**» indicator flashes.
- Press the «**Inicio** » button. The «**centrifugar-terminado**» indicator lights permanently.

Pausing a programme in course (depending on the model)

- Press the «**Inicio** » button during the washing cycle. The screen shows “*PAUS*” and the «**Inicio** » indicator flashes. The programme is paused.

! While the active programme is paused, it is not possible to add or remove laundry. For reasons of safety, the door will remain locked.





- Press the «**Inicio** » button once more. The programme continues, the «**Inicio** » indicator comes on permanently and the washing machine continues with the interrupted programme.

End of wash programme/Removing the laundry

The «centrifugar–terminado» indicator flashes and the screen shows “Εηδ”.

- Turn the programme selector to «Stop».

If “- - -” (**without final spin**) were selected, the screen shows “- - -”. The programme may then be continued or the water may be emptied:

- To continue with the running programme:
 - Select a washing speed by pressing the “⏻” button (except “- - -”).
 - Press the «Inicio » button.
 - After the programme has finished, turn the programme selector to «Stop».
- To empty the water:
 - Select an extra programme («» or « Centrif. adicional»).
 - Press the «Inicio » button.
 - After the selected extra programme has finished, turn the programme selector to «Stop».

Taking the laundry out of the machine

- Turn off the tap.
- Open the door.
- ! The door of the washing machine should not be opened during the washing cycle. To open the door, wait until the «centrifugar–terminado» indicator flashes and the screen shows “Εηδ” or turn the programme selector to «Stop» and wait at least 2 minutes.
- Take the laundry out of the machine.
- ! Remove foreign bodies and metallic objects (clips, coins etc.) which might have accumulated inside the drum or on the rubber seal. **Risk of rusting!**

Leave the door open so that air can circulate inside and dry the appliance.

- ! Before performing any type of maintenance work on the appliance, it must be disconnected from the mains and the tap turned off.

External cleaning of the appliance

- ! Do not use solvents! These products can damage parts of the appliance, form toxic vapours, harm your health and cause explosions.
- ! Do not clean the appliance by directing a jet of water at it.

Only clean the outside of the appliance and the controls with warm, soapy water or a standard cleaning product. Do not use abrasive or aggressive products. Dry with a soft cloth.

Cleaning the detergent drawer

- Remove the drawer completely from the appliance keeping the mobile part pressed downwards.
- Clean all the parts and elements under running water.
- Put the drawer back into the appliance.

Descaling the appliance

- ! Descaling agents contain acids which may attack the components of the appliance or cause discolouration in the laundry. Strictly observe the manufacturer's instructions.

Cleaning the drum

The rust stains caused by metallic objects must be cleaned with detergents which do not contain chlorine (note the description of the components appearing on the container!). Never use steel wool!

Cleaning the drainage pump

Cleaning is necessary:

- If the pump is blocked by foreign material (buttons, fasteners, clips...) or if dirty water is not drained.
- After washing fluffy items.

Before cleaning the pump, all water must be removed from inside the appliance. If the pump is obstructed as much as 20 litres of water may remain.

Procedure

- Turn the programme selector to «**Stop**».
- Open the front service flap.
- ! **Risk of burning!** Allow the used water to cool down.
- Loosen the cover without removing it completely to allow the water to empty gradually. When the container is full, close the drainage pump cover. Repeat the operation until all the water has been emptied. Use a suitable cloth to remove any remaining water which may spill on the floor.
- Loosen the drainage pump cover completely.
- Remove any foreign material or fluff which may have collected there. Wipe the inside of the pump. The blades must move freely.
- Coil and fit the drainage pump cover in place. Ensure that it is correctly closed.
- Fit the service flap in place.
- Pour 2 litres of water into the detergent drawer and start the «**سپش**» additional programme. This will prevent the detergent from being flushed out before being used in the next wash.



Cleaning the filters in the water inlet

The filters in the water inlet must be cleaned when, with the tap turned on, no water or only a very small amount enters the appliance.

The filters are located in the hose connection which joins the water inlet pipe to the mains tap, as well as in the connection of the solenoid valve at the rear of the appliance.

Procedure

○ Firstly empty the water pressure from the inlet pipe:

1. Turn off the tap.
2. Set the programme selector to any wash programme (except «» or « **Centrif. adicional**»).
3. Press the «**Inicio** » button. Let it run for at least 1 minute.
4. Turn the programme selector to «**Stop**».



- Unscrew the inlet pipe from the tap. Rinse the filter under running water.
- Screw the pipe to the tap again.
- Remove the water inlet pipe from its connection at the back of the machine.
- Remove the filter by using some flat-nose pliers; clean it and put it back in its position.
- Attach the pipe to its coupling.
- Turn on the tap and check that there are no water leaks.
- Turn off the tap.

Frost protection

Drain the water from the pump:

See «Cleaning the drainage pump».

Drain the water from the inlet pipe:

- Turn off the tap.
- Disconnect the inlet pipe from the tap. Put the end of the pipe in a receptacle.
- Select any wash programme (except «» or « **Centrif. adicional**») during 40 seconds. The water in the pipe is drained.
- Reattach the pipe to the closed tap.

Technical data

Width	59.5 cm
Height	85.0 cm
Depth	56.0 cm
Weight	approx. 70 kg

Mains voltage / Fuse: according to specifications plate

Water supply pressure 1–10 bar

Minor faults with simple solutions

! Repairs should be carried out by brand customer service or authorised technicians only. Any erroneous or incorrect repair may seriously endanger or cause considerable harm to the user.

Malfunction	Possible cause / Remedy
The function indicator does not come on Electrical power failure	The machine's plug is not connected or not properly connected to the power point. The fuse has blown. Electrical power failure. In the event of blackouts or faults in the appliance, an emergency drainage of the water may be performed in order to take the laundry out of the machine; see «Cleaning the water drain pump».
The wash cycle does not start	The «Inicio  » button has not been pressed. The door is not properly closed (the screen shows «E3»).
No water can be seen in the drum	This is not a malfunction. There is water in the appliance but it is beneath the visible area. The electronic control reduces consumption while maintaining all services.
Washing result is unsatisfactory	Abnormally high degree of soiling. Insufficient detergent. Measure out the detergent in line with the manufacturer's instructions. Select the most suitable wash programme for the laundry.
Foam comes out of the detergent drawer	Too much detergent has been used. Disconnect the appliance for 5 - 10 minutes. To prevent the build-up of foam, put a dessertspoon of softener mixed with half a litre of water in the detergent drawer. Reduce the amount of detergent used in your next wash.
Foam is visible after the final rinse	Some detergents produce a large quantity of foam although this has no effect on the rinsing result.
Strange motor noises	This is not a malfunction. During the heating stage, the motor produces noises characteristic of starting.
Pump noises	This is not a malfunction. These noises are characteristic of the machine starting and the pump discharging.
The machine vibrates when washing or spinning	The transport securing devices have not been removed. Note the instructions for installation. The adjustable feet on the machine were not fixed during installation. Level the machine and fix the supports according to the installation instructions.
The appliance does not spin or does not empty the water used	The drain pump is blocked, see «Cleaning the water drain pump»; the drain pipe is bent or blocked (the screen shows «E6» in both cases).
The door will not open	The security feature is activated. The option “- - - -” has been selected.
Water does not enter the washing machine	The water inlet filters are dirty, see «Cleaning the water inlet filters»; The tap is turned off (the screen shows «E5» in both cases).
Alterations in the time remaining	This is not a malfunction. The time remaining may be extended or reduced slightly during the washing cycle, depending on automatic adjustments or user selections (see «Screen»).
The screen shows «E2»	Motor fault. Contact the After Sales Service.

After Sales Service

- Before calling the After Sales Service Department, make sure you are not able to solve the problem yourself (see «Minor faults with simple solutions»).

In this way, you will avoid unnecessary costs, since the warranty does not cover cases where there is in fact no fault, or when the After Sales Service Department is called out to only provide instructions.

- ! If, in spite of these indications, a malfunction occurs, disconnect the appliance, pull the plug out of the socket and turn off the tap, before contacting the After Sales Service.

The address and telephone number of your nearest After Sales Service is in the attached directory.

Do not forget to indicate the product number (**E-Nr**) and serial number (**FD**), which are on the specifications plate, situated on the inside of the door frame.

Note the numbers of your machine here:

E-Nr. _____	FD _____
Product nr.	Serial nr.

Help prevent our technicians being called out on pointless journeys by providing the correct product and serial numbers, and by giving as precise an explanation as possible of the problem. This will save you unnecessary expense.

Consumption figures

Programme	Size of load	Consumption **		
		Energy	Water	Duration
Resistentes/Algod. intensivo 40 °C	6.00 kg*	0.85 kWh	58 l	1:50
Resistentes/Algod. intensivo 60 °C	6.00 kg	1.40 kWh	57 l	2:05
Resistentes/Algod. 60 °C Eco	6.00 kg*	1.02 kWh	47 l	2:15
Resistentes/Algod. intensivo 90 °C	6.00 kg	2.10 kWh	62 l	2:05
Sintéticos 40 °C	3.00 kg*	0.55 kWh	48 l	0:59
Mix 30 °C	3.00 kg*	0.35 kWh	48 l	0:52
Delicado 30 °C	2.00 kg	0.28 kWh	48 l	0:44
Lana/lã 30 °C	2.00 kg*	0.20 kWh	32 l	0:53

* Test programmes in accordance with EN 60456 and IEC 456.

** The consumption figures given are an approximate guide and may differ from the actual values depending on the pressure, hardness and temperature of the water, room temperature, the type and amount of laundry, the detergent used, fluctuations in electrical voltage and the additional functions selected.

Robert Bosch Hausgeräte GmbH
Carl-Wery Str. 34
81739 München / Deutschland

WAE20260EE /...
8911 en
9000420677